

**SUGGESTED RETAIL PRICES EFFECTIVE  
JUNE 1, 2010**

**MULTIPOINT TRIM  
PRICE LIST**



**LOCKSETS & ARCHITECTURAL HARDWARE OF FINE QUALITY**

# TECHNICAL INFORMATION

## 4 Easy Steps to Ordering OMNIA Multipoint Trim:

# 1

Select a plate with lever.  
(See catalog for options.)

# 2

Select a lock type.  
(ACA, ACB, ECB)

# 3

Select a function and handing.  
(Entrance/Patio/Pair Dummy Active/  
Pair Dummy Inactive)

# 4

Select a finish.

## LOCK TYPES

American Cylinder Above (ACA)

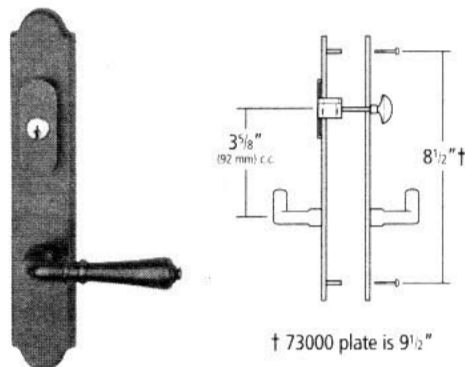

American Cylinder Below (ACB)

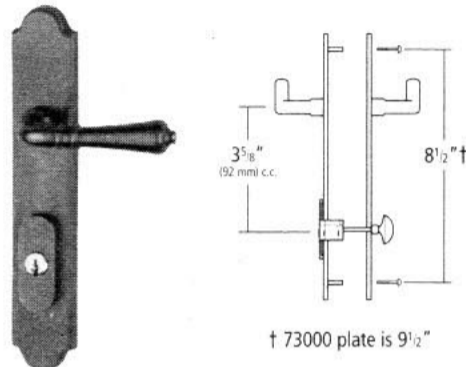

European Cylinder Below (ECB)

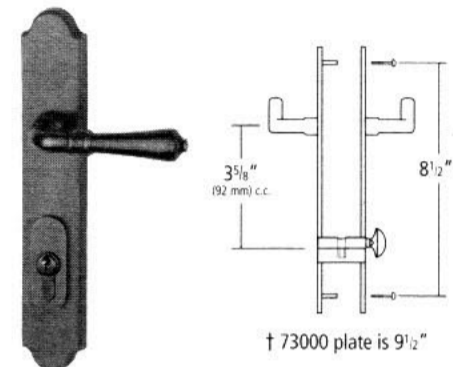

## FUNCTIONS

### Entry Function - ACA or ACB with American Cylinder

Active levers both sides. Key outside, by turnpiece inside.

Set Includes:

- 2 - Backplates
- 1 - Cylinder Collar mounted 3<sup>5</sup>/<sub>8</sub>" (92 mm) c.c. above or below the lever handles
- 2 - Levers with spindles
- 1 - American Cylinder with a lazy tailpiece
- 1 - Turnpiece
- 2 - Thru-bolt screws

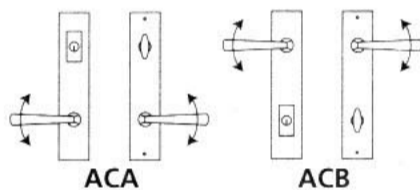

### Entry Function - ECB with European Cylinder

Active levers both sides. Key outside, by turnpiece inside.

Set Includes:

- 2 - Backplates
- 2 - Cylinder Collars mounted 3<sup>5</sup>/<sub>8</sub>" (92 mm) c.c. below the lever handles
- 2 - Levers with spindles
- 1 - European Profile Cylinder with key outside, turnpiece inside
- 2 - Thru-bolt screws

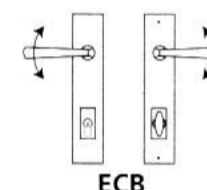

### Patio Function (PAT) - ACA or ACB

Active levers both sides. Turnpiece inside.

Set Includes:

- 2 - Backplates
- 2 - Levers with spindles
- 1 - Turnpiece
- 2 - Thru-bolt screws

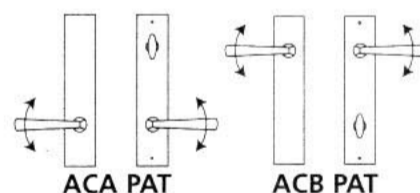

### Patio Function (PAT) - ECB

Active levers both sides. Turnpiece inside.

Set Includes:

- 2 - Backplates
- 2 - Levers with spindles
- 1 - Turnpiece Cylinder
- 2 - Thru-bolt screws

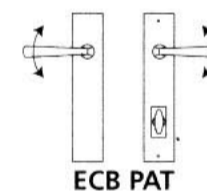

### Pair Dummy Active (PDA) - ACA, ACB, or ECB

Active lever inside, by inactive lever outside.

Set Includes:

- 2 - Backplates
- 2 - Levers with spindles
- 2 - Thru-bolt screws

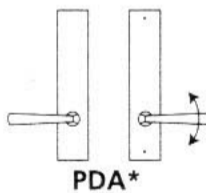

### Pair Dummy (PD) - ACA, ACB, or ECB

Inactive levers both sides.

Set Includes:

- 2 - Backplates
- 2 - Levers with spindles
- 2 - Thru-bolt screws

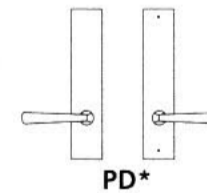

\*Drawing shows ACA only. Also available as ACB or ECB.

## FINISHES

- US3A - Polished, Unlacquered Brass
- US3 - Polished, Lacquered Brass
- US5A - Antique Bronze, Unlacquered
- US26 - Polished Chrome Plated
- US26D - Satin Chrome Plated

- US10B - Oil-Rubbed Bronze, Lacquered
- US14 - Polished Nickel Plated, Lacquered
- US15 - Satin Nickel Plated, Lacquered
- US32D - Brushed Stainless Steel
- SB - Shaded Bronze, Lacquered

See General Price List for "Terms and Conditions".



BOX 330 • CEDAR GROVE, NJ 07009 • PHONE (973) 239-7272 • FAX (973) 239-5960 • ORDER DESK FAX: 800-542-7611

# MULTIPOINT TRIM

SUGGESTED RETAIL PRICES EFFECTIVE JUNE 1, 2010

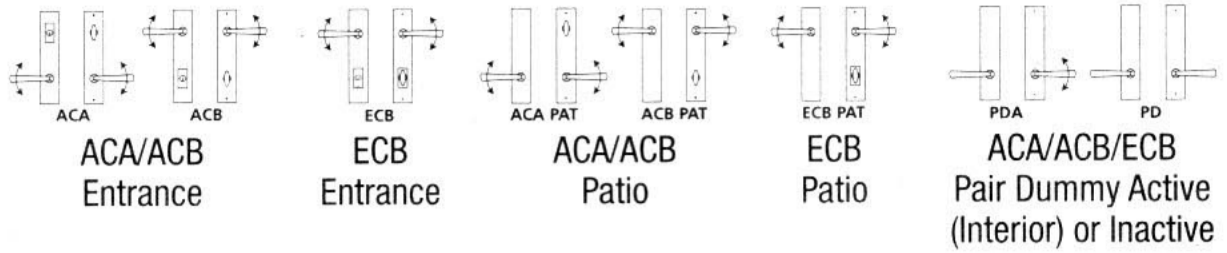

## 71000 SERIES

### 71055\*



US3A	292.00	362.00	234.00	292.00	213.00
US3	293.00	368.00	234.00	298.00	217.00
US5A	294.00	396.00	235.00	326.00	222.00
US10B	348.00	417.00	283.00	345.00	253.00
US14	320.00	410.00	258.00	338.00	232.00
US15	310.00	385.00	248.00	313.00	231.00
SB	297.00	396.00	238.00	325.00	221.00

### 71706

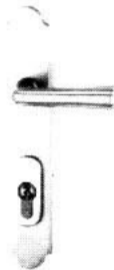

US3A	255.00	324.00	196.00	254.00	175.00
US3	255.00	330.00	196.00	260.00	179.00
US5A	256.00	358.00	197.00	287.00	183.00
US10B	311.00	379.00	245.00	307.00	215.00
US14	282.00	371.00	219.00	299.00	193.00
US15	272.00	347.00	210.00	274.00	192.00

### 71752

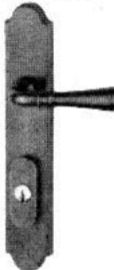

US3A	233.00	302.00	175.00	233.00	153.00
US3	234.00	308.00	174.00	238.00	158.00
US5A	234.00	336.00	175.00	266.00	162.00
US10B	289.00	357.00	223.00	285.00	194.00
US14	261.00	350.00	198.00	278.00	172.00
US15	251.00	326.00	189.00	253.00	171.00
SB	237.00	336.00	178.00	266.00	161.00

### 71858\*



US3	238.00	313.00	179.00	243.00	163.00
US10B	294.00	362.00	228.00	290.00	199.00
US14	266.00	356.00	204.00	283.00	177.00
US15	256.00	331.00	194.00	258.00	176.00
SB	242.00	341.00	183.00	270.00	166.00

### 71904

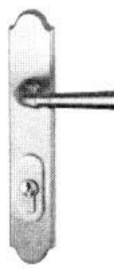

US3A	273.00	342.00	214.00	272.00	193.00
US3	273.00	348.00	214.00	278.00	197.00
US5A	274.00	376.00	215.00	306.00	202.00
US10B	329.00	397.00	263.00	325.00	233.00
US14	300.00	390.00	238.00	318.00	212.00
US15	291.00	366.00	229.00	293.00	211.00

### 71944

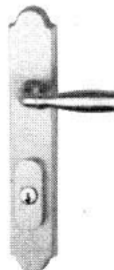

US3A	275.00	345.00	217.00	275.00	196.00
US3	276.00	351.00	217.00	280.00	200.00
US5A	276.00	378.00	217.00	308.00	204.00
US10B	331.00	400.00	266.00	328.00	236.00
US14	302.00	392.00	240.00	320.00	214.00
US15	292.00	367.00	230.00	295.00	212.00

\*Specify Right Hand or Left Hand when ordering.



BOX 330 • CEDAR GROVE, NJ 07009 • PHONE (973) 239-7272 • FAX (973) 239-5960 • ORDER DESK FAX: 800-542-7611

# MULTIPOINT TRIM

SUGGESTED RETAIL PRICES EFFECTIVE JUNE 1, 2010

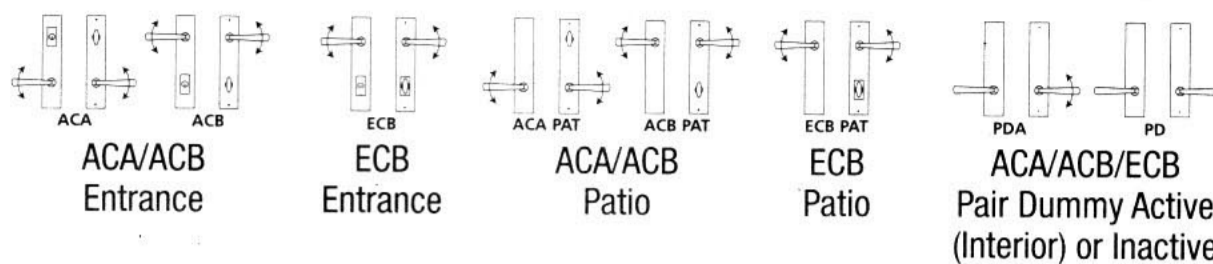

## 72000 SERIES

### 72036

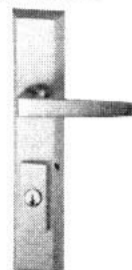

US26	242.00	352.00	181.00	266.00	180.00
US26D	258.00	351.00	197.00	283.00	180.00
US10B	303.00	366.00	238.00	297.00	208.00
US15	248.00	335.00	186.00	265.00	185.00

### 72042\*

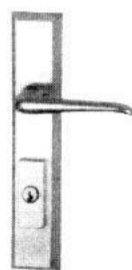

US26	245.00	355.00	184.00	269.00	183.00
US26D	261.00	355.00	201.00	286.00	183.00
US10B	306.00	369.00	241.00	300.00	212.00
US15	251.00	338.00	190.00	268.00	189.00

### 72220\*



US26	227.00	337.00	166.00	252.00	165.00
US26D	244.00	337.00	183.00	268.00	165.00
US10B	296.00	359.00	231.00	290.00	201.00
US15	232.00	320.00	171.00	250.00	170.00

### 72227\*

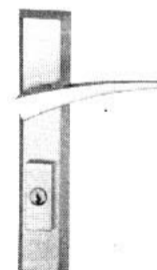

US26	284.00	394.00	224.00	309.00	223.00
US26D	301.00	394.00	240.00	326.00	223.00
US10B	352.00	415.00	287.00	346.00	257.00
US15	291.00	378.00	229.00	308.00	228.00

### 72282\*

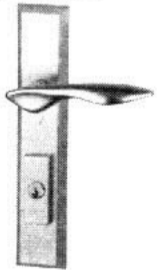

US26	246.00	356.00	185.00	271.00	184.00
US26D	263.00	356.00	202.00	287.00	184.00
US10B	314.00	377.00	249.00	308.00	220.00
US15	251.00	339.00	190.00	269.00	189.00

### 72368

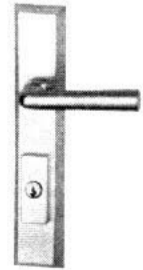

US26	249.00	359.00	188.00	273.00	187.00
US26D	265.00	359.00	205.00	290.00	187.00
US10B	310.00	373.00	245.00	304.00	216.00
US15	255.00	342.00	193.00	272.00	192.00

\*Specify Right Hand or Left Hand when ordering.



BOX 330 • CEDAR GROVE, NJ 07009 • PHONE (973) 239-7272 • FAX (973) 239-5960 • ORDER DESK FAX: 800-542-7611

# MULTIPOINT TRIM

SUGGESTED RETAIL PRICES EFFECTIVE JUNE 1, 2010

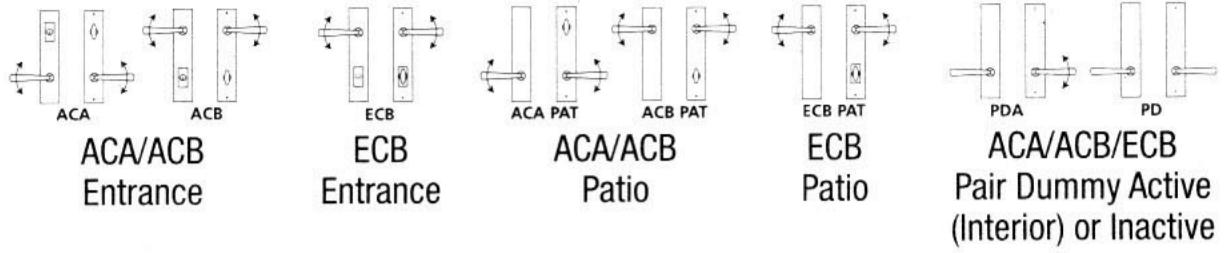

## 72000 SERIES

### 72914

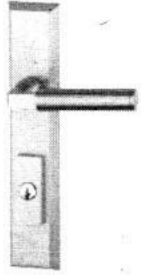

US26	287.00	397.00	226.00	311.00	225.00
US26D	303.00	397.00	243.00	328.00	225.00
US10B	354.00	417.00	289.00	348.00	260.00
US15	293.00	380.00	232.00	310.00	231.00

### 72943

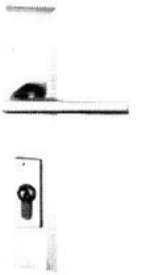

US26	251.00	361.00	190.00	275.00	189.00
US26D	267.00	361.00	207.00	292.00	189.00
US10B	312.00	376.00	247.00	306.00	218.00
US15	257.00	344.00	195.00	274.00	194.00

## 73000 SERIES

### 73011

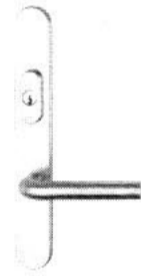

US32D	252.00	209.00	156.00	115.00	126.00
-------	--------	--------	--------	--------	--------

### 73012

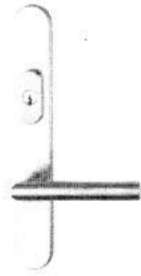

US32D	255.00	212.00	159.00	117.00	129.00
-------	--------	--------	--------	--------	--------

### 73023

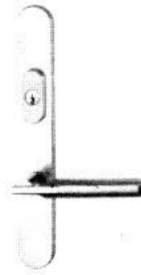

US32D	310.00	267.00	214.00	173.00	184.00
-------	--------	--------	--------	--------	--------

### 73025

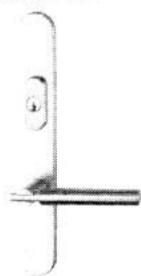

US32D	324.00	282.00	229.00	187.00	198.00
-------	--------	--------	--------	--------	--------



BOX 330 • CEDAR GROVE, NJ 07009 • PHONE (973) 239-7272 • FAX (973) 239-5960 • ORDER DESK FAX: 800-542-7611

# MULTIPOINT TRIM

SUGGESTED RETAIL PRICES EFFECTIVE JUNE 1, 2010

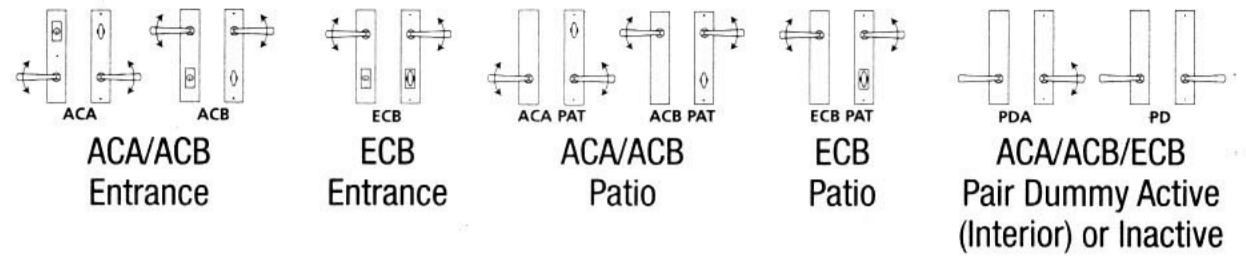

## 73000 SERIES

**73033**

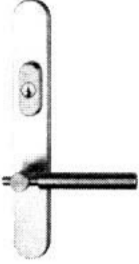

US32D

307.00

264.00

211.00

170.00

181.00

**73043**

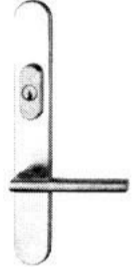

US32D

329.00

286.00

233.00

192.00

203.00



BOX 330 • CEDAR GROVE, NJ 07009 • PHONE (973) 239-7272 • FAX (973) 239-5960 • ORDER DESK FAX: 800-542-7611